

BROGLIPLAST

qualidade em tudo que faz!



Catálogo 2016



Tubos de Combustível



BRO.01.10.001

Tubo de Combustível - entrada e retorno

Aplicações:

Palio 1.0 e 1.5 - 8V - Todos MPFI (exceto Fire)



BRO.01.10.002

Tubo de Combustível - entrada da flauta

Aplicações:

Brava 01/... 1.6 - 16V - Palio 01/... - Siena 01/... (exceto Fire)



BRO.01.10.003

Tubo de Combustível - entrada e retorno

Aplicações:

Fiorino Baú 1.5 - 8V 97/... - Fiorino Pick-up 1.5 97/02 - Mille 99/01 MPFI



BRO.01.10.004

Tubo de Combustível - entrada da flauta

Aplicações:

Palio / Siena c/ motor Fire 8V 1.0 e 1.3 Fase I e II



BRO.01.10.005

Tubo de Combustível - entrada e retorno

Aplicações:

Palio 1.0, 1.3 e 1.5 8V 96



BRO.01.10.006

Tubo de Combustível - entrada e retorno

Aplicações:

Palio 1.0 -8V 96/01 - Palio 1.6 - 16V 96/00, Palio Fase I 03/04
Palio Weekend 1.0 -8V 99/00 - Siena 1.0 -8V 99/00
Siena 1.6 -16V 98/00 - Siena Fase I 03/04



BRO.01.10.007

Tubo de Combustível - entrada e retorno

Aplicações:

Palio / Siena 1.6 -8V motor Argentino



BRO.01.10.008

Tubo de Combustível - entrada

Aplicações:

Fiorino 03/... - Fire Mile 02/... - Uno 03/... Fire 8V



BRO.01.10.009

Tubo de Combustível - entrada

Aplicações:

Palio / Siena com motor Fire 16V 1.0 e 1.3 fase 1 e 2

Conectores Rápidos e Adaptadores

LANÇAMENTO



BRO.01.11.002

Conector Capa Preta (com anéis de Viton - 1 interno e 2 externos)

Aplicações:
5/16" x 5/16" (8mm x 8mm)

LANÇAMENTO



BRO.01.11.003

Conector 90° (com anéis de Viton - 1 interno e 2 externos)

Aplicações:
5/16" x 5/16" (8mm x 8mm)

LANÇAMENTO



BRO.01.11.004

Conector Capa Cinza (com anéis de Viton - 1 interno e 2 externos)

Aplicações:
5/16" x 5/16" (8mm x 8mm)

LANÇAMENTO



BRO.01.11.022

Adaptador 90° Bico Longo (com anel de Viton)

Aplicações:
5/16" x 5/16" (8mm x 8mm)

LANÇAMENTO



BRO.01.11.064

Adaptador Reto Bico Longo (com anel de Viton)

Aplicações:
5/16" x 5/16" (8mm x 8mm)

LANÇAMENTO



BRO.01.11.586

Pino pedal da embreagem

EAN 7L 586 AA

Aplicações:
KA 97 à 2007
Ecosport 2007 à 2012
Fiesta 2007 à 2013

Tubos de Hidrovácuo de Freios



BRO.01.09.001

R.O.: 96FB.2420.FA

Tubo Hidrovácuo Freio Ford

Aplicações:
Ford Fiesta e Courier – Motor Enduro.
Fiesta 96/99
Courier 97/99



BRO.01.09.002

R.O.: 97KB.2420.BA

Tubo Hidrovácuo Freio Ford

Aplicações:
Ford Ka 97/99



BRO.01.09.003

R.O.: 2S65.2420.AH

Tubo Hidrovácuo Freio Ford

Aplicações:
Fiesta 02/...



BRO.01.09.004

R.O.: 2N15.2420.BH

Tubo Hidrovácuo Freio Ford

Aplicações:
Ecosport 1.6 03/10



BRO.01.09.005

R.O.: BG3AK.2420.AA1 / BG3AK.2420.AA

Tubo Hidrovácuo Freio Ford

Aplicações:
Ford Ka 99/07



BRO.01.09.006

R.O.: XS61.2420.BC

Tubo Hidrovácuo Freio Ford

Aplicações:
Fiesta Street
99/06



BRO.01.09.007

R.O.: 7S55.2420-AA

Tubo Hidrovácuo Freio Ford

Aplicações:
Ford Novo Ka



BRO.01.09.008

R.O.: 9N15.2420.AC
RN15.2420.AC / 9615.2420.AC

Tubo Hidrovácuo Freio Ford

Aplicações:
Ecosport Flex 2.0 Flex
Transmissão Normal 08/10 12



BRO.01.09.009

R.O.: 3M51.2420-CS

Tubo Hidrovácuo Freio Ford

Aplicações:
Novo Focus Sigma



BRO.01.09.010

R.O.: 3M51.2420 KV

Tubo Hidrovácuo Freio Ford

Aplicações:
Novo Focus



BRO.01.09.011

R.O.: 96FB 2420 EA

Tubo Hidrovácuo Freio Ford

Aplicações:
Courier 96/99 Motor Zetec Se 1.4 16v,
Fiesta 96/99 Motor Zetec Se 1.4 16v

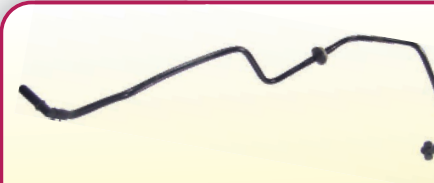

BRO.01.09.012

R.O.: 2S65 2420 DB

Tubo Hidrovácuo Freio Ford

Aplicações:
Fiesta 00/06 Motor Rocan 1.0 Gasolina,
Fiesta 02/06 1.0 Supercharger Motor Rocan Freio Abs



BRO.01.09.013

R.O.: 98AG 2420 LA

Tubo Hidrovácuo Freio Ford

Aplicações:
Focus Sedan 02/04 Motor Zetec 2.0 16v Gasolina,
Focus Hatch 00/05 1.0 Supercharger, Focus
Sedan E Hatch 02/05 Motor Zetec 2.0 16v Gas. Trans. Automática



BRO.01.09.014

R.O.: 98AG 2420 ED

Tubo Hidrovácuo Freio Ford

Aplicações:
Focus 00/02 Motor Zetec 2.0 16v Gasolina,
Focus 02/05 Motor 126cv Transmissão Manual



BRO.01.09.015

R.O.: 5S45 2420 AC

Tubo Hidrovácuo Freio Ford

Aplicações:
Focus 05/08 Motor 2.0 Transmissões Manual e Automática

Tubos de Hidrovácuo de Freios



LANÇAMENTO

BRO.01.09.016 R.O.: 3S45 2420 AA
 Tubo Hidrovácuo Freio Ford
Aplicações:
 Focus 1.6, Focus 03 A 11/09



LANÇAMENTO

BRO.01.09.017 R.O.: 2565.2420 BC
 Tubo Hidrovácuo Freio Ford
Aplicações:
 Fiesta 1.0 Supercharge 04/06 s/ ABS
 Sedan Hatch 02/07



LANÇAMENTO

BRO.01.09.018 R.O.: 93BB.2420 AE
 Tubo Hidrovácuo Freio Ford
Aplicações:
 Mondeo 98/01 motor 2.5 V6
 Sedan



LANÇAMENTO

BRO.01.09.021 R.O.: 5171 2917
 Tubo Hidrovácuo Freio Fiat
Aplicações:
 Palio fase I e II
 Palio Weekend (todos),
 Siena fase I, II e III



BRO.01.09.022 R.O.: 4684.5144
 Tubo Hidrovácuo Freio
Aplicações:
 Palio Fase 1 (01-07) Fase 2 (04-04) Fase 3 (08-12)
 Palio Weekend (todos) (01-07) Fase 2 (04-04) Fase 3 (08-12)
 Siena (01-07) Fase 2 (04-04) Fase 3 (08-12) Fase 4 (03-15)



BRO.01.09.040 R.O.: 9328 5302
 Tubo Hidrovácuo Freio GM
Aplicações:
 Classic 99/09
 Corsa Hatch, Pick-up,
 Wagon 1.0, 1.4 e 1.6 fase I



LANÇAMENTO

BRO.01.09.041 R.O.: 9037 5312
 Tubo Hidrovácuo Freio GM
Aplicações:
 Celta 07/09, Classic 00/10,
 Corsa Hatch, Corsa Pick-up, Wagon 96/10
 Prisma 07/09



LANÇAMENTO

BRO.01.09.042 R.O.: 9326 0736
 Tubo Hidrovácuo Freio GM
Aplicações:
 Celta 00/07



LANÇAMENTO

BRO.01.09.043 R.O.: 9023 5599
 Tubo Hidrovácuo Freio GM
Aplicações:
 Omega GI, Suprema GI, Omega GIs, Suprema GLS /
 Motor 4 Cilindros 2.0l Gasolina Mpi 8 Valvulas,
 Motor 4 Cilindros 2.0l Mpi Alcool Fp + Ie4/I78 93/95



LANÇAMENTO

BRO.01.09.044 R.O.: 9470 3021
 Tubo Hidrovácuo Freio GM
Aplicações:
 Agile 10/13, Celta 09/14
 Montana 10/13
 Prisma 09/13



LANÇAMENTO

BRO.01.09.060 R.O.: 5Z061 2041 H
 Tubo Hidrovácuo Freio VW
Aplicações:
 Toda Linha Fox
 e Spacefox



LANÇAMENTO

BRO.01.09.061 R.O.: 1JE61 2041 A
 Tubo Hidrovácuo Freio VW
Aplicações:
 Golf 1.6 09/13
 Golf 99/... 1.6,
 A3 00/... 1.6, A4 99/... 1.6



LANÇAMENTO

BRO.01.09.062 R.O.: 5H161 2041C
 Tubo Hidrovácuo Freio VW
Aplicações:
 Gol G5
 Saveiro Cross 11/...

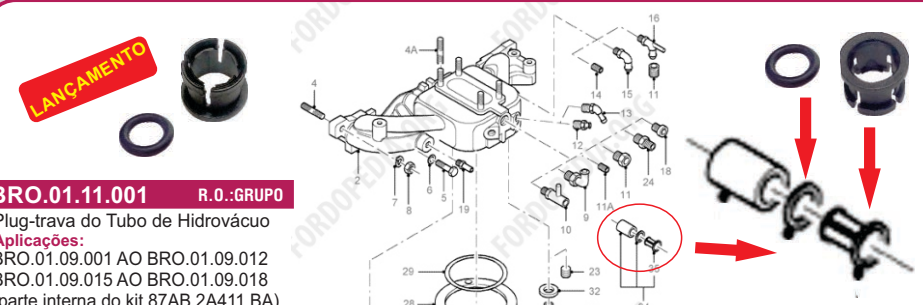

LANÇAMENTO

BRO.01.11.001 R.O.: GRUPO
 Plug-trava do Tubo de Hidrovácuo
Aplicações:
 BRO.01.09.001 AO BRO.01.09.012
 BRO.01.09.015 AO BRO.01.09.018
 (parte interna do kit 87AB 2A411 BA)

Tubos de Cilindro-Mestre de Embreagens



BRO.01.08.001 R.O.: 1S55.7A512.AA
 Tubo Cilindro-Mestre Embreagem Ford
Aplicações:
 Ford Ka 97/07

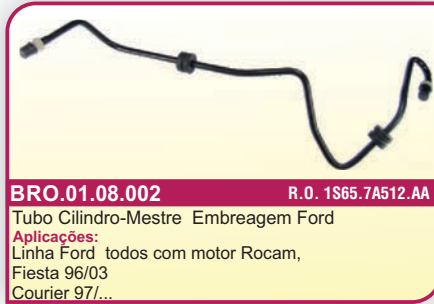

BRO.01.08.002 R.O.: 1S65.7A512.AA
 Tubo Cilindro-Mestre Embreagem Ford
Aplicações:
 Linha Ford todos com motor Rocam,
 Fiesta 96/03
 Courier 97/...

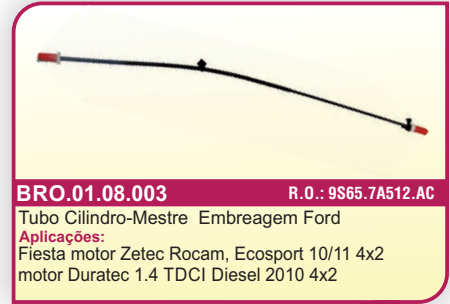

BRO.01.08.003 R.O.: 9S65.7A512.AC
 Tubo Cilindro-Mestre Embreagem Ford
Aplicações:
 Fiesta motor Zetec Rocam, Ecosport 10/11 4x2
 motor Duratec 1.4 TDCI Diesel 2010 4x2

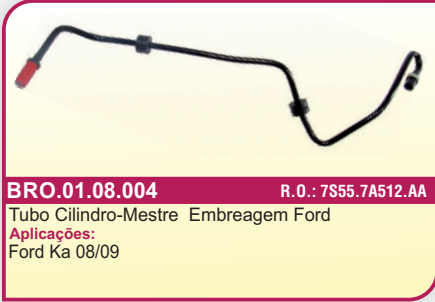

BRO.01.08.004 R.O.: 7S45.7A512.AA
 Tubo Cilindro-Mestre Embreagem Ford
Aplicações:
 Ford Ka 08/09

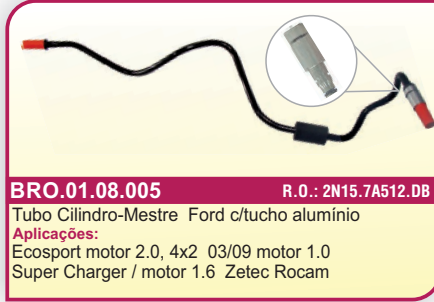

BRO.01.08.005 R.O.: 2N15.7A512.DB
 Tubo Cilindro-Mestre Ford c/tucho alumínio
Aplicações:
 Ecosport motor 2.0, 4x2 03/09 motor 1.0
 Super Charger / motor 1.6 Zetec Rocam



BRO.01.08.006 R.O.: 2N15.7A512.EC
 Tubo Cilindro-Mestre Ford c/tucho alumínio
Aplicações:
 Ecosport motor Duratec
 He 2.0 03/10 4x2



BRO.01.08.007 R.O.: 2S65.7A512.BA
 Tubo Cilindro-Mestre Ford c/tucho alumínio
Aplicações:
 Fiesta Zetec Rocam,
 Fiesta Sedan Ago04.../ Hatch Abril02/...

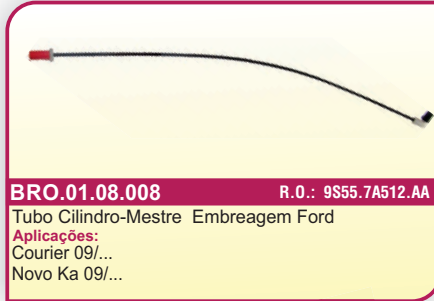

BRO.01.08.008 R.O.: 9S55.7A512.AA
 Tubo Cilindro-Mestre Embreagem Ford
Aplicações:
 Courier 09/...
 Novo Ka 09/...

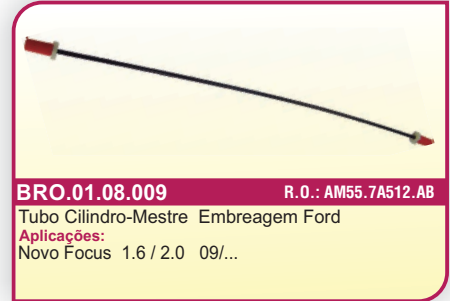

BRO.01.08.009 R.O.: AM55.7A512.AB
 Tubo Cilindro-Mestre Embreagem Ford
Aplicações:
 Novo Focus 1.6 / 2.0 09/...



BRO.01.08.010 R.O.: 5S45.7A512.AB
 Tubo Cilindro-Mestre Ford c/tucho alumínio
Aplicações:
 Focus 05/08 com Câmbio Manual
 motor Duratec

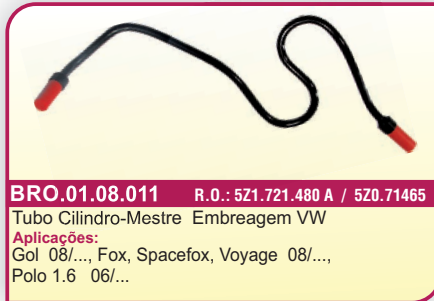

BRO.01.08.011 R.O.: 5Z1.721.480 A / 5Z0.71465
 Tubo Cilindro-Mestre Embreagem VW
Aplicações:
 Gol 08/..., Fox, Spacefox, Voyage 08/...,
 Polo 1.6 06/...

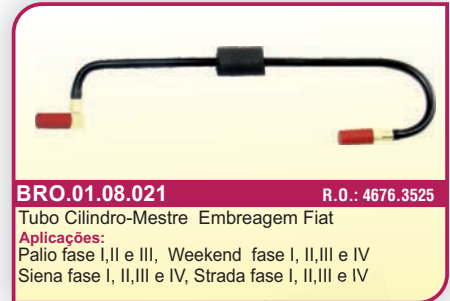

BRO.01.08.021 R.O.: 4676.3525
 Tubo Cilindro-Mestre Embreagem Fiat
Aplicações:
 Palio fase I, II e III, Weekend fase I, II, III e IV
 Siena fase I, II, III e IV, Strada fase I, II, III e IV

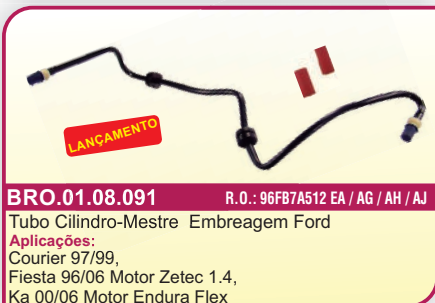

BRO.01.08.091 R.O.: 96FB7A512 EA / AG / AH / AJ
 Tubo Cilindro-Mestre Embreagem Ford
Aplicações:
 Courier 97/99,
 Fiesta 96/06 Motor Zetec 1.4,
 Ka 00/06 Motor Endura Flex

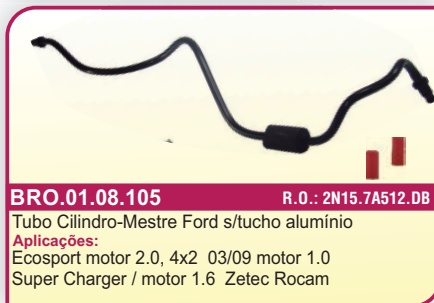

BRO.01.08.105 R.O.: 2N15.7A512.DB
 Tubo Cilindro-Mestre Ford s/tucho alumínio
Aplicações:
 Ecosport motor 2.0, 4x2 03/09 motor 1.0
 Super Charger / motor 1.6 Zetec Rocam



BRO.01.08.106 R.O.: 2N15.7A512.EC
 Tubo Cilindro-Mestre Ford s/tucho alumínio
Aplicações:
 Ecosport motor Duratec
 He 2.0 03/10 4x2



BRO.01.08.107 R.O.: 2S65.7A512.BA
 Tubo Cilindro-Mestre Ford s/tucho alumínio
Aplicações:
 Fiesta Zetec Rocam,
 Fiesta Sedan Ago04.../ Hatch Abril02/...

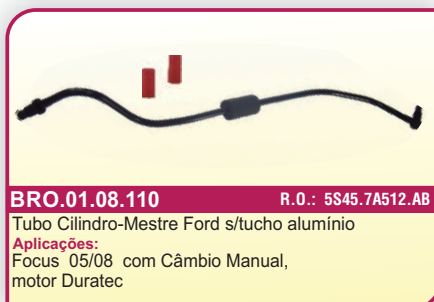

BRO.01.08.110 R.O.: 5S45.7A512.AB
 Tubo Cilindro-Mestre Ford s/tucho alumínio
Aplicações:
 Focus 05/08 com Câmbio Manual,
 motor Duratec



BRO.01.08.100
 Tucho de Alumínio Adaptador
Aplicações:
 Adaptador para 2N15.7A512.DB / 2N15.7A512.EC /
 2S65.7A512.BA / 5S45.7A512.AB, entre outros

Flanges e Conexões



BRO.01.07.001

R.O.: 06A.103.213

Cotovelo Respiro Óleo Torcido

Aplicações:

Audi A3 1.6, 1.8 Aspirados 99/05,
Golf 1.8 20v Aspirado 96/06



BRO.01.01.005

R.O.: 06A.103.213.F

Cotovelo Respiro Óleo 90°

Aplicações:

Audi A3 1.8 Turbo 20v 99/05,
Golf A4 98/05, Golf My08 07/...,
Passat, Variant 01/05, Polo Hatch Gti 06



BRO.01.06.001

R.O.: 1J0.121.291.B / 1J0.122.291.B

Conexão Água Ar Quente

Aplicações:

Audi A3 98/06, Golf A4 99/...,
Bora My08 07/...,
Bora 02/..., Golf My08 07/...



BRO.01.06.002

R.O.: 1J0.121.087.A

Conector do fluxo de água com sensor 1j0**087a

Aplicações:

Golf A4, Bora .../02 1.6, 1.8, 2.0
Audi A3 96/00 1.6, 1.8, 2.0
Gas. C/lar



BRO.01.06.006

R.O. 1J0.121.291-D / 1J0.122.291-D

Conexão Água Ar Quente

Aplicações:

Audi A3 00/06 1.6 L 8v, 1.8 L 20v Turbo 4cil. Gas.
Golf A4 .../99 1.6 L, 1.8 L, 2.0l - Gas, Golf My08,
Bora 02/..., Bora My08 07/...



BRO.01.06.007

R.O.: 1J0.122.291

Conexão Rápida Superior Radiador

Aplicações:

Audi A3 99/06 1.6 L, 1.8 L 20v Turbo 1.9 L
Bora 2.0 00/...
Polo Sedan 1.4 L 02/...



BRO.01.06.008

R.O.: 357.121.140 / 357.121.140.S

Tampão com Trava

Aplicações:

Audi A3 99/05, Golf 94/98, Golf A4 98/..., Golf My08 07/..., Fox,
Spacefox, Parati 95/02, Saveiro 94/..., Gol 95/99, Bora 00/...,
Bora My08, New Beetle 99/..., Toureg, Gol Especial Gii 02/...,
Saveiro Giii 02/..., Parati Giii 02/..., Gol Giv 05/..., Saveiro
Giv 05/..., Parati Giv 05/..., Polo-hatch Gti, Sedan 06/..., Classic
96/..., Cordoba Ibiza 96/..., Passat, Variant 94/01 e Caddy



BRO.01.06.011

R.O.: 026.121.144.E / 026.121.144.E

Flange Entrada Água

Aplicações:

Polo Classic 96/..., Inca,
Caddy, Audi 100 / 80 / A6



BRO.01.06.012

R.O.: 030.121.121.B

Flange Válvula Termostática

Aplicações:

Passat, Golf,
Audi A4 A6 1.6 1.8 95/...,
Jetta, Variant 96/02



BRO.01.06.013

R.O.: 032.121.118.D

Cotovelo de saída de Água

Aplicações:

Fox, Polo, Kombi Motor EA 111



BRO.01.06.014

R.O.: 032.121.121.J

Bocal do Tubo

Aplicações:

Polo Classic 00/..., VW Caddy,
Bora, Golf, Polo,
Vento, Ibiza 2001-02



BRO.01.06.015

R.O.: 037.121.132.B

Flange com anel de vedação

Aplicações:

Audi 100 2.0 Dez90/jul91, Audi 80 1.8 2.0 Mar88/dez91,
Golf, Jetta (não Rv/pn) 1.6 1.8 Ago88/out91, Passat 1.6
Abr88/ago91, Passat 2.0 Mar90/set94, Passat (55 Quilowatts)
1.8 Abr88/set96 Passat (66 Quilowatts) 1.8 Abr88/jul91



BRO.01.06.016

R.O.: 037.121.121.A

Flange Fluxo de Água

Aplicações:

Golf 1.8 2.0 .../98, Passat, Variant 94/...,
Cordoba 95/..., Polo Classic 96/03, Ap/efi
Caddy, Ibiza 1.8 95/99, Inca



BRO.01.06.017

R.O.: 037.121.132.E

Flange c/ Acoplamento p/ Sensor Temperatura

Aplicações:

Golf (Imp) 94/98 Gl 96/98 (México), Passat,
Variant 2.0 Efi 94/97, Polo Classic 00/...,
Cordoba, Ibiza 1.5 95/96 Glx 96/99 SXE (Arg.)



BRO.01.06.018

R.O.: 037.121.132.C

Flange com Anel Vedação

Aplicações:

Audi A3 Nacional, Golf,
Passat,
Caddy



BRO.01.06.019

R.O.: 037.121.133.B

Flange Fluxo Água

Aplicações:

Audi 100 2.0 Dez90/jul91, Audi 80 1.8 2.0 Mar88/dez91,
Golf, Jetta (não Rv/pn) 1.6 1.8 Ago88/out91, Passat 1.6 Abr88/
ago91, Passat 2.0 Mar90/set94, Passat (55 Quilowatts) 1.8
Abr88/set96, Passat (66 Quilowatts) 1.8 Abr88/jul91



BRO.01.06.020

R.O.: 037.121.133.C

Flange Fluxo Água

Aplicações:

Passat, Jetta,
Golf .../95,
Cordoba .../95



BRO.01.06.021

R.O.: 038.121.132.C

Flange Fluxo Água

Aplicações:

Golf A4, Audi A3 99/..., Polo, Audi A2,
Bora Hatch/sedan 02/06, Fox,
Cordoba, Golf My08

Flanges e Conexões



BRO.01.06.022

R.O.: 055.121.121.F

Flange Fluxo Água

Aplicações:

Passat Importado .../97,
Golf, Audi 100 A4 A6,
Jetta



BRO.01.06.023

R.O.: 058.121.132.B

Flange com Anel Vedação

Aplicações:

Passat
Variant 98/01



BRO.01.06.024

R.O.: 058.121.133.B

Flange Fluxo Água

Aplicações:

Audi A4 .../97,
Passat Importado 95/96



BRO.01.06.026

R.O.: 068.121.132.B

Flange com Anel Vedação

Aplicações:

Gol, Saveiro 94/...,
Cordoba, Golf III 1h1 96/...,
Ibiza, Caddy, Inca



BRO.01.06.027

R.O.: 068.121.144

Flange com Anel Vedação

Aplicações:

Golf, Audi Nacional,
Passat .../95,
Jetta .../95



BRO.01.06.028

R.O.: 06A.121.121-C

Flange do Termostato VW

Aplicações:

Golf A4 98/..., Audi A3 1.6 1.8 2.0 99/...,
New Beetle 2.0 99/..., Cordoba 1.6 99/03, Ibiza 99/...,
Bora 00/..., Golf My08 07/..., Bora My08 07/...,
Polo Sedan/Hatch 02/..., Hatch Gti 06/...



BRO.01.06.029

R.O.: 06A.121.132

Flange Fluxo Água

Aplicações:

Golf A4 98/..., Cordoba, Ibiza 99/..., Fox 1.6
Bora 00/..., Polo Hatch, Sedan 02/..., Polo Hatch 2.0,
Golf My08 07/..., New Beetle 05/..., Audi A3



BRO.01.06.030

R.O.: 06A.121.132.A

Flange Fluxo Água

Aplicações:

Golf A4 1.6 1.8 2.0 2.8 20v
Turbo 1.9 Arg. 98/..., Audi A3 99/..., Audi TT,
New Beetle 99/...



BRO.01.06.031

R.O.: 2S6G.8250.A1B

Flange Termostato

Aplicações:

Ecosport 03/..., Fiesta 02/..., Zetec Rocam 1.0 1.6
Courier 02/..., Focus 03/...,
Zetec Rocam 1.6 Gas.



BRO.01.06.032

R.O.: 06A.121.133.F

Flange com Anel Vedação

Aplicações:

Golf
Jetta turbo



BRO.01.06.033

R.O.: 06A.121.132.AP / 06A.121.132.Q
R.O.: 06A.121.133 / 06A.121.133.J

Flange Fluxo Água

Aplicações:

Golf A4 1.8 20v Turbo 99/02, Audi A3 1.6 8v
99/00, Golf A3 1.8 20v Turbo 98/99, Golf A4
1.8 20v Turbo 99/02, Jetta, Bora, Golf, Audi,
Passat 1.8, Audi A3 TT,



BRO.01.06.034

R.O.: 6Q0.122.291.E

Conexão Rápida Superior do Radiador

Aplicações:

Fox 1.0 1.6 03/04, Spacefox 1.6 8v Gas. Flex 06/...,
Polo Hatch, Polo 1.4 1.6 02/..., Sedan 02/..., Jetta
2.5 Tiptronic 06, Jetta Variant My08 06/...



BRO.01.06.035

R.O.: 6Q0.122.291.F

Conexão Rápida

Aplicações:

Golf A4 98/..., Fox, Bora 00/04, Bora My08 07/...,
Audi A3 99/05, New Beetle 99/..., Spacefox, Polo
Hatch, Sedan 02/..., GTI 06/..., Golf My08 07/...



BRO.01.06.036

R.O.: 1J0.122.109.AQ

Conexão «Y»

Aplicações:

Golf A4 1.6 1.8 1.9 2.0 2.8 98/01, Fox 1.0 1.6
03/04, Bora 00/04, Audi A3 1.6 1.8 1.9 99/05,
New Beetle 2.0 8v 4 Cil. 99/..., Polo Hatch,
Sedan 1.4, 1.6, 2.0 02/..., Polo GTI 1.8 4 Cil.
Turbo 06/..., Spacefox 1.6 8v 06/...



BRO.01.06.037

R.O.: 1J0.121.087.C

Conexão Fluxo Água

Aplicações:

Golf, Audi A4, Bora 99/01,
Audi A3 96/... 1.6 1.8 2.0 8 20V gas. S/Ar



BRO.01.06.038

R.O. 1J0.121.087-B

Conexão Fluxo Água

Aplicações:

Polo Sedan, Cordoba, Ibiza, Audi A3,
Golf A4 1.9 4 Cil- Diesel 99/...
Córdoba 1.6 S/ar 99/...



BRO.01.06.040

R.O.: 3B0.122.291.B

Flange de Conexão de Ar Quente

Aplicações:

Audi A3 03/12 / Audi MKI 99/12, Golf IV e Jetta IV 09/12
Passat 06/12, Tiguan 08/11
New Beetle 98/10 / Bora



BRO.01.06.041

R.O.: 1J0.122.101.CC

Conexão Fluxo Água

Aplicações:

Audi A3 Turbo 1.8 2003/...; Audi A4 Turbo 1.8 2003/...;
Golf Bola Turbo 1.8 2004/...;
New Beetle Turbo 1.8 2003/...

LANÇAMENTO

Tubos de Arrefecimento e Acessórios

BRO.01.50.500

R.O.: 93.267.581

Tubo Fluxo Água

Aplicações:
Kadett, Ipanema 82/90
Monza 82/... 1.8,
2.0 EFI/MPFI Sem Ar Quente



BRO.01.50.501

R.O.: 52.289.682

Tubo Fluxo Água

Aplicações:
Kadett 89/98,
Ipanema 82/90 - Monza 89/96 1.8,
2.0 EFI/MPFI cem Ar Quente



BRO.01.50.502

R.O.: 90.448.854

Tubo Fluxo Água

Aplicações:
Corsa 94/...
1.0, 1.4, 1.6
8V Com Ar Quente



BRO.01.50.503

R.O.: 9.128.719

Tubo Fluxo Água

Aplicações:
Corsa 02/...
MPFI Gas. Com Ar -
Meriva 03/... 1.8 8V ou 16V.



BRO.01.50.504

R.O.: 90.501.079

Tubo Fluxo Água

Aplicações:
Corsa 95/...
1.0L, 1.4L, 1.6L MPFI 16V
Tigra 98 1.6 MPFI Gas C/Ar



BRO.01.50.505

R.O.: 93.288.617

Tubo Fluxo Água

Aplicações:
Celta 01/... 1.0L, 1.4L
MPFI Gas S/Ar



BRO.01.50.506

R.O.: 93.288.618

Tubo Fluxo Água

Aplicações:
Celta 01/... 1.0L, 1.4L
MPFI Gas C/Ar



BRO.01.50.507

R.O.: 90.322.216

Tubo Fluxo Água

Aplicações:
Astra GL, GLS, Zafira 99/... 1.8L, 2.0L MPFI 8V
Alc/Gas/Flex - Kadett/Ipanema 97/98
Vectra 94... 2.0 / MPFI 8V Gas.

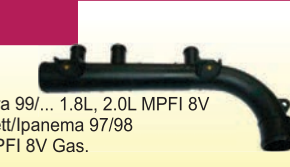

BRO.01.50.508

R.O.: 90.530.728

Tubo Fluxo Água

Aplicações:
Astra GL, GLS, Zafira 99/... 1.8L, 2.0L,
2.4L MPFI 8/16V Alc./ Gas./ Flex
Com Ar

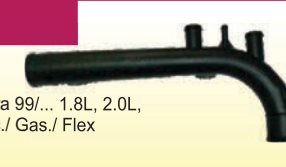

BRO.01.50.509

R.O.: 90.354.641

Tubo Fluxo Água

Aplicações:
Astra GLS 95/96
1.8, 2.0 8/16V



BRO.01.50.510

R.O.: 90.354.840

Tubo Fluxo Água

Aplicações:
(Astra Alemão)



BRO.01.50.511

R.O.: 93.254.183

Tubo Fluxo Água

Aplicações:
Vectra CD, GL,
GLS 97/98 2.0L,
2.2L MPFI 16V Gas.



BRO.01.50.512

R.O.: 93.276.411

Tubo Fluxo Água

Aplicações:
Omega GL, GLS 95/98
2.0L, 2.2L MPFI 4Cil.
8V Alc./ Gas. S/Ar



BRO.01.50.513

R.O.: 93.276.410

Tubo Fluxo Água

Aplicações:
Omega GL, GLS 93/98
2.0L, 2.2L MPFI
4Cil. 8V Alc./ Gas. C/Ar



BRO.01.50.514

R.O.: 032.121.065

Tubo Fluxo Água

Aplicações:
Gol/ Saveiro/ Parati 97/... Fox 03/... 1.0L,
1.6L Flex/ Gas. A3 02/06, Golf A4 01/...
Spacefox 06/... 1.6L 8V, Ibiza/ Polo Classic AT
1.0 EFI 8/16V - Polo 02/... 1.4L, 1.6L 8/16V
polo Sedan, Golf A4 02/... 1.6L Flex/ Gas./ Alc.



BRO.01.50.515

R.O. 46.822.096

Tubo Fluxo Água

Aplicações:
Pálio/ Siena 03/04 Gas. 05/06 Flex/ Dobl6/
Adventure 04/06 Gas. 06/... Flex/ Stilo 03/06 Gas.
06/... Flex/ Idea 06/... Flex Todos 1.8 MPI 8V
Stilo 03/... 1.8 MPI 16V



BRO.01.50.517

R.O.: 90.556.948

Válvula de aquecimento 2 vias

Aplicações:
Corsa 98/ ... 1.0L, 1.6L MPFI 16V
Vectra 97/...



BRO.01.50.518

R.O.: 90.566.947

Válvula de aquecimento 3 vias

Aplicações:
Corsa 98/03 1.0L, 1.4L, 1.6L
MPFI 8V, Vectra GL, GLS, CD
97/03 2.0L, 2.2L MPFI 8/16V Gas.



BRO.01.50.519

R.O.: 030.121.121.C

Cotovelo Válvula Termostática

Aplicações:
Fox 02/... 1.0L, 1.6L Flex/ Gas. A3 02/06,
Golf A4 01/... Spacefox 06/... 1.6L 8V
Gol/ Parati 97/... Ibiza/ Polo Classic AT 1.0
EFI 8/16V, Polo 02/... 1.4L, 1.6L 8/16V
Polo Sedan/ Golf A4 02/... 1.6L Flex/ Gas. Alc.



BRO.01.50.520

R.O.: 46.417.193

Anti-Chama Defletor

Aplicações:
Pálio/Siena/Strada/
Uno Mille 1.0 MPI 8V Todos



BRO.01.50.521

R.O.: 327.129.101.1

Válvula reguladora anti-chama

Aplicações:
Ford/VW Motor AP 1.8, 2.0 Motor
MWM Série - 10



BRO.01.50.522

R.O.: 036.103.464.F

Defletor anti-chama

Aplicações:
Gol/ Parati/
Saveiro AT 8V 97/...
16V 06/00
Córdoba / Ibiza 8V



BRO.01.50.523

R.O.: 036.103.464.J

Defletor anti-chama

Aplicações:
Gol/ Parati/
Saveiro AT 09/97 02/02 16V
Córdoba / Ibiza 16V



BRO.01.50.524

R.O.: 96BM.6K614.AC

Tampa de óleo e válvula anti-chama

Aplicações:
Courier/ Fiesta/ KA 98/99
Motor Endurance



BRO.01.50.525

R.O.: 94.702.833

Tubo fluxo de água

Aplicações:
Corsa Classic/
Sedan/ Meriva/
Montana 09/... 1.0, 1.4, 1.8
Flex/ Gas.



BRO.01.50.526

R.O.: 94.704.072

Tubo fluxo de água

Aplicações:
Celta/ Prisma 09...
1.0, 1.4
Flex/ Gas



BRO.01.50.527

R.O.: 90.448.853

Tubo fluxo de água

Aplicações:
Chevy 94/96



Tubos de Arrefecimento

BRO.01.50.528
R.O.: 93.378.094

Tubo fluxo de água

Aplicações:
Corsa/ Montana 06/...
1.0L, 1.4L, 1.6L, 1.8L
MPFI 8/16V Alc./ Gas./ Flex C/ Ar

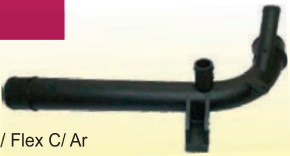

BRO.01.50.529
R.O.: 82.001.345.13

Tubo fluxo de água

Aplicações:
Scenic/ Megane
1.6 16V 99/06



BRO.01.50.530
R.O.: 517.510.510

Tubo fluxo de água

Aplicações:
Pálio 1.8R, Adventure, HLX, Weekend HLX/
Siena HLX/ Stilo Sporting/ Strada Adventure/
Trekking 1.8 MPI
Flex 8V 07/...



BRO.01.50.531
R.O.: 9.128.718

Tubo fluxo de água

Aplicações:
Astra G 98/... 1.6
(Exportação)



BRO.01.50.532
R.O.: XS6E.9K478.F

Carcaça da válvula termostática

Aplicações:
Ecosport 00/... Fiesta, Ka
99/... Zetec Rocam 1.0,
1.6 Courier 99/..., Focus 03/...
Zetec Rocam 1.6 Gas./ Flex



BRO.01.50.533

R.O.: XS6E.9K478.F / XS6E.8250.AD

Carcaça da válvula termostática

Montada com flange
(BRO.535) + Válvula
Termostática
Aplicações:
Fiesta, Ka, Escort,
Courier 99/02 Zetec Rocam 1.0, 1.6 Gas.



BRO.01.50.534

R.O.: XS6G.9K478.F / 2S6G.8250.A1B

Carcaça da válvula termostática Montada
com flange (BRO.01.06.031) +
Válvula Termostática

Aplicações:
Fiesta, Ka, Escort, Courier,
Ecosport, Focus 02/...
Zetec Rocam 1.0, 1.6 Gas.



BRO.01.50.535

R.O.: XS6E.8250.AD

Flange da válvula termostática

Aplicações:
Fiesta 99/02, Ka 99/... Zetec Rocam 1.0, 1.6,
Courier 99/02, Ecosport 00/02 Zetec
Rocam 1.6 Gas.



BRO.01.50.536

R.O.: 036.103.464.G

Anti-Chama Defletor

Aplicações:
Fox 1.6 Flex Polo 1.6 Gas.
Golf 2000/...



BRO.01.50.537

R.O.: 036.103.464.P

Anti-Chama Defletor

Aplicações:
Gol Power 8/16V 2001/...
Fox03/... 1.0 Flex



BRO.01.50.539

R.O.: 030.121.111.T

Cavelete de Distr. de água 1 Saída

Aplicações:
Gol/Parati 02/... 1.0 MI AT 8/16V S/ Ar
Gol 02/05 Gol Special 94/02
Parati 00/04 1.0 AT 16V S/ Ar



BRO.01.50.540

R.O.: 030.121.111.AC = Conj. 030.131.111.S

+ 030.121.121.C + 032.121.110.C

Cavelete Distr. de água 1 Saída

Aplicações:
Gol /Parati 02/... 1.0 MI AT 8/16V
S/ Ar Gol 02/05 Gol Special 94/02
Parati 00/04 1.0 AT 16V
S/Ar (80° + - 2° C)



BRO.01.50.541

R.O.: 030.131.111.S + 030.
121.121.C + 032.121.065

Cavelete Distr. de água 1 Saída

Aplicações:
Gol /Parati 02/... 1.0 MI AT 8/16V S/ Ar Gol 02/05
Gol Special 94/02 Parati 00/04 1.0 AT 16V S/ Ar +
Tubo 032/121065 (80° + - 2° C)



BRO.01.50.542

R.O.: 030.121.111.AS

Cavelete Distr. de água c/ 2 saídas

Aplicações:
Gol/Parati 02/... 1.0 MI AT 8/16V C/ Ar
Gol 02/05 Gol Special 94/02
Parati 00/04 1.0 AT 16V C/ Ar



BRO.01.50.543

R.O.: 030.121.111.S = Conj. 030.131.111.S

+ 030.121.121.C + 032.121.110.C

Cavelete Distr. de água c/ 2 saídas

Aplicações:
Gol/ Parati 02/... 1.0 MI AT 8/16V C/ Ar
Gol 02/05 Gol Special 94/02
Parati 00/04 1.0 AT 16V C/ Ar (80° + - 2° C)



BRO.01.50.544

R.O.: 030.121.111.AS +
030.121.121.C + 032.121.065 +
VÁLVULA TERM.

Cavelete Distr. de água c/ 2 saídas

Aplicações:
Gol/ Parati 02/... 1.0 MI AT 8/16V C/ Ar
Gol 02/05 Gol Special 94/02 Parati 00/04 1.0 AT 16V
C/ Ar + Tubo 032/121065 (80° + - 2° C)

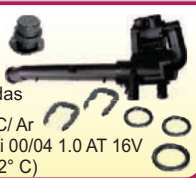

BRO.01.50.545

R.O.: 032.121.026

Cavelete de Distr. de água c/ 3 saídas

Aplicações:
Fox 03/... 1.0, 1.6 Polo 02/... 1.0, 1.4, 1.6
Spacefox 06/... 1.6 Flex
Polo 01/03 1.0 EFI 16V 02/...
1.4L 16V Gas.



BRO.01.50.546

R.O.: 032.121.026 + 030.121.121 +

032.121.118.D BRO.01.06.013

com válvula termostática

Cavelete de Distr. de água c/ 3 saídas

Aplicações:
Fox 03/... 1.0, 1.6 Polo 02/... 1.0, 1.4, 1.6
Spacefox 06/... 1.6 Flex (80° + - 2° C) Polo 01/03
EFI 16V 02/... 1.4L 16V Gas (87° + - 2° C)

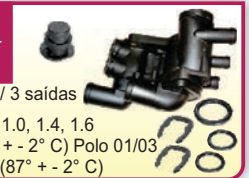

BRO.01.50.547

R.O.: 032.121.026 + 030.121.121.C
R.O.: 032.121.065 + VÁLVULA TERM.

Cavelete de Distr. de água c/ 3 saídas

Aplicações:
Fox 03/... 1.0, 1.6 Polo 02/...
1.0, 1.4, 1.6 Spacefox 06/... 1.6 Flex (80° + - 2° C)
Polo 01/03 EFI 16V 02/... 1.4L 16V Gas
(87° + - 2° C) C/ tubo 032/121065

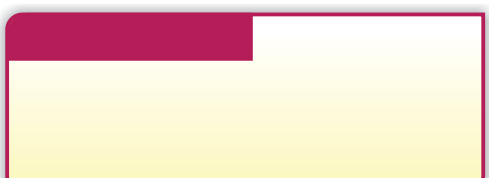
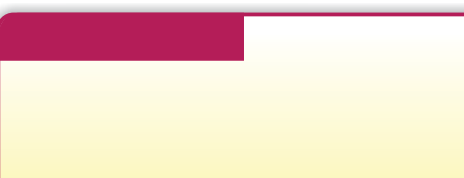
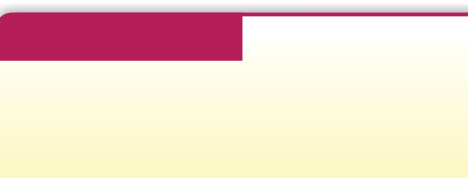
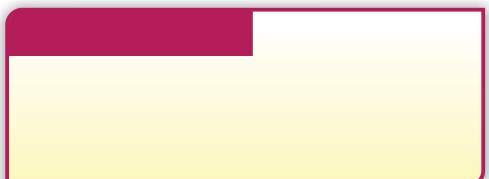
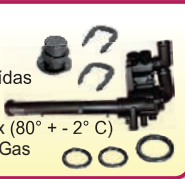

Acessórios

BRO.01.01.002
BRO.01.01.003
BRO.01.01.004

Prolongador Cuba do Carburador 2E Preto / Azul / Vermelho
Aplicações: para Carros Turbinados / Mexidos



BRO.01.01.006
BRO.01.01.007
BRO.01.01.008

Prolongador Cuba do Carburador 3E Preto / Azul / Vermelho
Aplicações: para Carros Turbinados / Mexidos



BRO.01.06.003
R.O.: 8L0.881.671

Botão Regulagem Banco Preto

Aplicações: Audi A3



BRO.01.06.004
R.O.: 1J0.881.671.F

Botão Regulagem Banco Cinza Claro

Aplicações: Golf A4 99/..., Golf My08, New Beetle 99/..., Bora, Fox, Spacefox, Passat, Variant 98/..., Polo Hatch, Polo Sedan Gti 06/..., Classic 00/...



BRO.01.06.005
R.O.: 1J0.881.671.F

Botão Regulagem Banco Cinza Escuro

Aplicações: Golf A4 99/..., Golf My08, New Beetle 99/..., Bora, Fox, Spacefox, Passat, Variant 98/..., Polo Hatch, Polo Sedan Gti 06/..., Classic 00/...



BRO.01.06.009
R.O.: 078.103.604.T

Tampa do Carter T

Aplicações: Bloco do Motor ACK 2.8 Aga 2.4 30 válvulas - 97/..., Audi A4, Audi A4 avant, S4 Quattro, Audi A6 S6 Avant 4, Audi A8, Audi A80



BRO.01.06.010
R.O.: 078.103.604.H

Tampa do Carter H

Aplicações: Bloco do Motor AAH 6cc, Audi A4 94/97, Audi A4 S4, Audi A4 avant quattro 95/97, Audi A6 95, Audi A6 S6 95, Audi A8 95/97, Audi A80 94/96

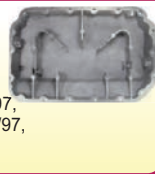

BRO.01.06.039

Trava do Sensor embalagem contém 12 unidades

Aplicações: Todos os carros VW e Ford



BRO.01.50.600

Kit

Kit alav. Câmbio c/ tirante

Aplicações: Escort/Verona/ Apollo 1.8



BRO.01.50.601

Kit

Kit alav. Câmbio s/ tirante

Aplicações: Escort/Verona/ Apollo 1.8



BRO.01.50.602

Kit

Kit (Parcial) alav. Câmbio s/tirante

Aplicações: Escort/Verona/ Apollo 1.8



BRO.01.50.603

Tirante do Kit

Aplicações: Escort/Verona/ Apollo 1.8



BRO.01.50.700
R.O.: 93.240.238

Alça dianteira do teto

Aplicações: Corsa 99/... Vectra 97/... Astra 99/... Celta 01/...



BRO.01.50.701
R.O.: 90.431.606

Presilha Fixação Forro Acabamento GM unitário

Aplicações: GM (todos anos / modelos)



BRO.01.50.702
R.O.: 93.268.818

Retentor Moldura Portas

Aplicações: Omega 93/...



BRO.01.50.703
R.O. 93.270.052

Cob. ext. porta tras. LE

Aplicações: Corsa 95/...



BRO.01.50.704
R.O. 93.270.053

Cob. ext. porta tras. LD

Aplicações: Corsa 95/...



BRO.01.50.705
R.O. 93.281.253

Cob. int. porta tras. LE

Aplicações: Corsa 99/...



BRO.01.50.706
R.O.: 93.281.254

Cob. int. porta tras. LD

Aplicações: Corsa 99/...



BRO.01.50.707
R.O.: 3278.37187.1999

Pino Trava-porta

Aplicações: VW



BRO.01.50.708
R.O.: 3058.67171.2999

Puxador de Porta

Aplicações: Gol geração I Kombi Nova



BRO.01.50.714
R.O.: 1J0.121.087.C

Bucha do Varão (PU)

Aplicações: Fusca, Brasília



BRO.01.50.715
R.O.: 327.823.397.1

Grampo da Vareta do Capô

Aplicações: Gol/Voyage/ Parati/ Saveiro/Satana



BRO.01.50.716
R.O.: 90.191.598

Presilha vareta do Capô

Aplicações: Monza 91/96 Kadett Astra 95/96



BRO.01.50.717

Presilha vareta Capô

Aplicações: Ford



BRO.01.50.719

Bucha Cremalheira Fiat unitário

Aplicações: Tipo, Tempra (todos Anos/modelos)



tubos e válvulas arrefecimento - botões regulação banco- tampa carter - flanges e



Rua Coronel Euclides Machado, 429 - Jd. das Graças - 02713-000 - SP

PABX: 55 11 3936-4880 / Fax: 55 11 3931-2494

www.brogliplast.com.br

4colors.com.br

